

FT15S905D3BACAPOB

v1: GL: 3030514617 | EU: 1010502713



Pictures show sample configurations, real product may vary.

DISPLAY

Display Size [inch]	15.0
Aspect Ratio	4:3
Resolution	1024 × 768
Active Area [mm]	304.1 × 228.1
Brightness [cd/m²]	420
Contrast Ratio	800 : 1
LED life time [h]	30000
Viewing Angle [°]	176 / 176
Display Interface	LVDS

TOUCH PANEL

Touch Type	Projected Capacitive 10-point Multi-touch
Printing Type	Organic
Glass Thickness [mm]	1.1
Cover Glass Surface Treatment	AG
IK Protection	IK7
Printing Color	RAL9004 (Black)
Strengthening	Thermally Strengthened
Touch Controller	EXC81W84
Touch Interface	USB
Touch Resolution RX	48
Touch Resolution TX	36
Optical Bonding	Clear Bond®

PC/MONITOR SYSTEM

Processor	Amlogic S905D3
Chipset	Quad-Core Cortex A-53
Standard Operating System	Android 9
OS Available on Request (additional fee)	Linux Ubuntu 22.4, Debian 12 *
RAM Size	2 GB LPDDR4
EMMC Size	64 GB eMMC 5.1
GPU	Mali G31 MP2
NPU	1.2Tops
Loudspeaker	2× 2W
Wifi + BT	RTL8821 + Bluetooth 4.0
SD Card Slot	1
USB 3.0	1
USB 2.0	1
USB OTG	1
Ethernet Network (10/100/1000 Mbit/s)	1
Serial Port RS232 (RX / TX only)	1

ENVIRONMENTAL CONDITIONS

Operation Temperature	-10°C to 60°C
Storage Temperature	-20°C to 60°C
Humidity Range	10% to 90%

CERTIFICATIONS

CE Certificate	Yes
FCC Certificate	Yes

CHASSIS

Case Design	Rubber Frame Sealing
Case Size	Small
IP Protection	IP65 Front / IP40 Back
Case Color	RAL9004 (Black)
Case Coating	Powder Coating
Case Material	Aluminum
Case size L × W × H [mm]	359.0 × 291.0 × 55.0
Cut-out for clamp supports L × H [mm]	335.0 × 267.0
Max. wall thickness for clamp supports [mm]	5.0
Amount of clamps required	6
Mounting	VESA 100 × 100

SERIAL (RS232) PIN DEFINITION

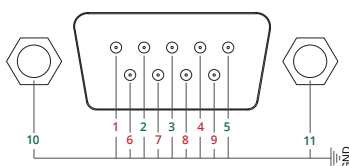

2	RXD1
3	TXD1
5	GND
10	GND
11	GND

* Pyramid Computer GmbH is not affiliated with Debian. Debian is a registered trademark owned by Software in the Public Interest, Inc. Debian 12 OS does not require additional fee.

ACCESSORIES

Power Adapter	100-240V ACDC active switching; 12V DC-Out
Wifi Antenna	RP-SMA female
Short Instruction manual	Yes

INTENDED USE/APPLICATION

The device is to be used as (touchscreen) display for indoor use as control panel, digital signage, way-finding, POS and similar applications.

Direct sunlight might increase the device temperature beyond the allowed storage and operation conditions. Therefore the devices must be protected against direct sunlight. Devices operated or stored outside the specified temperature ranges are not covered by warranty.

POWER

Power Indicator	Green LED
Working Power	12V
Power Consumption	13.8W
Stand-By Consumption [Android / Ubuntu]	<1W / <3W

WEIGHT & PACKAGING

Net Weight	~3.50 kg est.
Gross Weight	~5.40 kg est. (incl. Cartonage)
Packaging Material	100% recyclable cardboard and polyethylene (PE)
Packaging Size L x W x H [mm]	515.0 x 372.0 x 80.0

Front kit & Back kit concept:

- Pre-assembled or separately packaged available
- Easily replace or switch back kits and front kits
- Connected through various connectors
- Assembly to be done by a professional

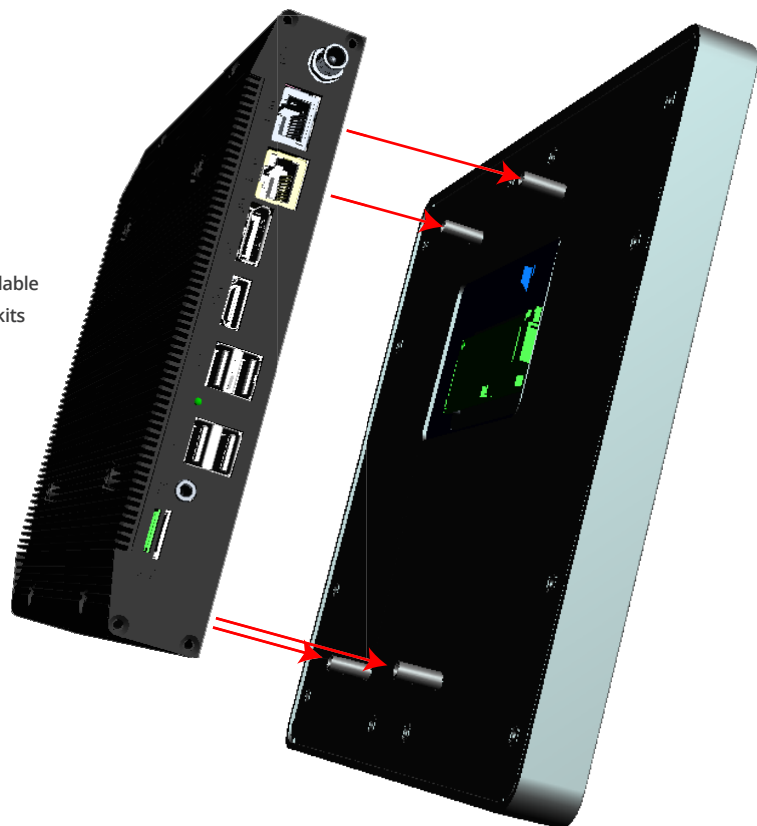

DIMENSIONS

Pictures show sample configurations, real product may vary.

15" RUBBER FRAME FRONT KIT

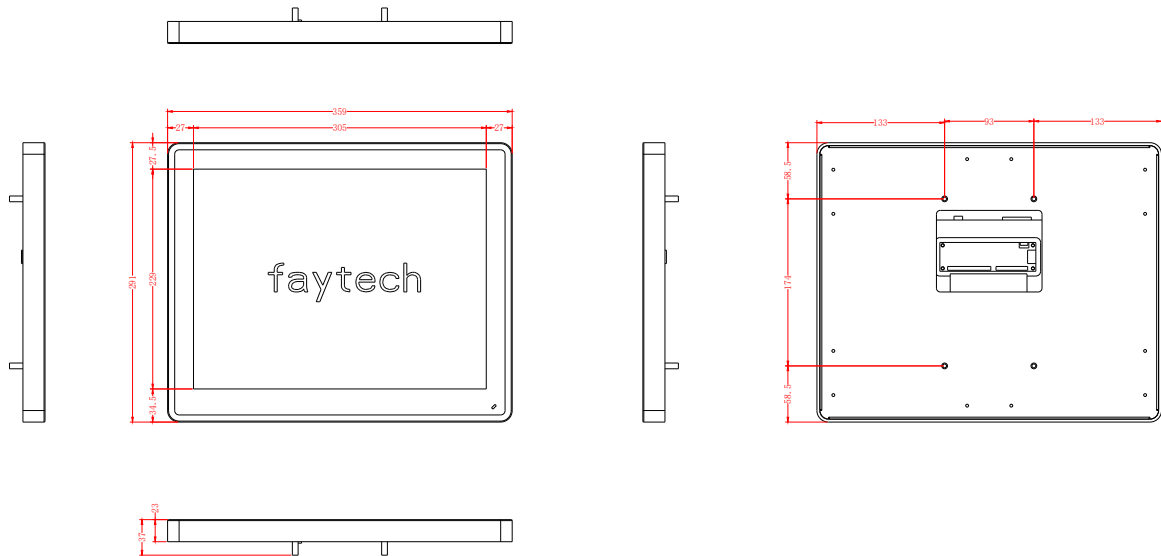

SMALL IPC BACK KIT BASIC (S905D3)

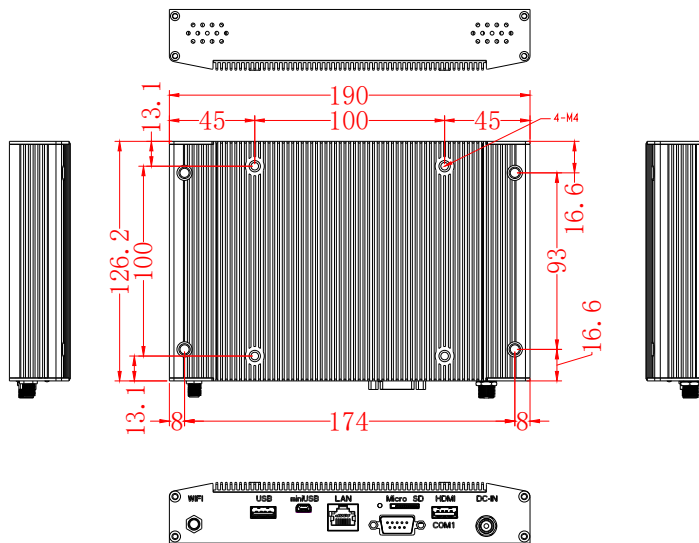

UPDATE NOTES:

Version: _____ Changes: _____
 v1 _____ First version _____