

Intel-based Modular Capacitive Touch PCs

FAYTECH®

Elkhart Lake & Tiger Lake U Series

Installation, safety and user manual



Elkhart Lake

x6413E | x6211E | J6412

Tiger Lake U

i5-1145G7E | i3-1115G4E | i7-1185G7E

Version 1.0

CONTENT

1. FOREWORD.....	4
1.1 Notes on documentation	4
2. SAFETY, OPERATION & MAINTENANCE	5
2.1 Explanation of the safety symbols	5
2.2 Basic security measures	6
2.3 Duty of care for the operator	7
2.4 Requirements for the operating personnel	7
2.5 General Warning	7
3. WARRANTY	8
3.1 Warranty claims & repair	8
3.2 Life support policy warning	9
3.3 In case of defect	9
4. PRODUCT DESCRIPTION.....	10
4.1 Appropriate use.....	10
4.2 Interfaces	11
4.3 Status LED	12
4.4 Scope of delivery	13
5. INSTALLATION INSTRUCTIONS.....	14
5.1 Transportation	14
5.2 Unpacking	14
5.3 Mounting options.....	15
5.4 Connecting the device	17
5.5 Driver installations	18
6. OPERATING INSTRUCTIONS.....	19
6.1 Initial power-up and driver installation.....	19
6.2 BIOS settings	19
6.3 Troubleshooting	20
6.4 FAQs	20

7. SERVICE AND SUPPORT	21
7.1 Service.....	21
7.2 Contact.....	21
8. APPENDIX.....	22
8.1 CE and UKCA - Declaration of Conformity	22

1. FOREWORD

Please read this manual carefully prior to use of the product, and keep it properly.

1.1 Notes on documentation

This description is intended exclusively for trained specialists in controlling and automation technology who are familiar with the applicable national standards. For installation and commissioning of the components it is absolutely necessary to observe the following notes and explanations. The qualified personnel must ensure that the application or use of the described products meets all safety requirements, including all applicable laws, regulations, provisions and standards.

Disclaimer

This documentation has been carefully prepared. However, the products described are subject to continuous further development. Therefore, the documentation is not always completely checked for compliance with the described performance data, standards or other features. If it contains technical or editorial errors, we reserve the right to make changes at any time and without notice. The information, illustrations and descriptions in this documentation do not constitute grounds for claims for changes to products already supplied.

Copyright

© faytech / © Pyramid Computer GmbH

Passing on and reproduction of this document, use and communication of its contents are prohibited unless expressly permitted. All rights reserved in case of patent, utility model or design patent registration.

State of delivery

All components are delivered in specific hardware and software configurations depending on the application requirements. Changes to the hardware or software configuration, which go beyond the documented possibilities are not permitted and result in the exclusion of liability of faytech and Pyramid Computer GmbH.

Modular solution

Although this touch display is a modular version consisting of a front kit and back kit, the solution is pre-assembled by faytech, and delivered as a complete solution. Please do not separate or open the unit as it voids the warranty and might destroy the device. If you are interested in delivery of these components separately, please talk to one of our sales experts.





Notice on waste recycling

If this Product is no longer needed or reaches its service life, it shall be submitted to the qualified recycling plants recognized by state in accordance with the relevant laws and regulations for recycling of waste electric products in order to care and protect our earth.

2. SAFETY, OPERATION & MAINTENANCE

2.1 Explanation of the safety symbols

The following safety symbols are used in these operating instructions. These symbols are primarily intended to draw the reader's attention to the text of the adjacent safety instructions.

 DANGER	<p>Acute danger of injury!</p> <p>If the safety instruction next to this symbol is not observed, there is an immediate danger to life and health of persons.</p>
 WARNING	<p>Caution Risk of injury!</p> <p>If the safety instruction next to this symbol is not observed, there is a danger to life and health of persons.</p>
 CAUTION	<p>Injury to persons!</p> <p>If the safety instruction next to this symbol is not observed, persons may be injured.</p>
 Attention	<p>damage to the environment or equipment</p> <p>If the note next to this symbol is not observed, the environment or equipment may be damaged.</p>
 Note	<p>Tip or pointer</p> <p>This symbol indicates information that contributes to better understanding.</p>

2.2 Basic security measures

Below are some basic security measures to ensure proper operation of the Touch PCs.

 Attention	<p>Switch off all system components, then disconnect the fieldbus</p> <p>Before opening the Touch PC housing and whenever the Touch PC is not used for control purposes, for example during the functional test after a repair, all system parts must first be switched off and then the Touch PC must be disconnected from the system.</p> <p>Switched off system parts must be secured against being switched on again.</p>
---	--

 Attention	<p>Do not replace any parts when under voltage</p> <p>When installing and removing components, the supply voltage must be switched off.</p> <p>Damage can occur during installation in the Touch PC:</p> <ul style="list-style-type: none">• If metal objects such as screws or tools are placed in the circuit boards.• If PC internal connection cables are pulled off or plugged in during operation.
--	--

2.3 Duty of care for the operator

The operator must ensure that:

- The Touch PC is only used for its intended purpose (see chapter Product Description).
- The Touch PC is only operated in a faultless, fully functional condition.
- The operating manual is always available in a legible condition and complete at the place of use of the Touch PC.
- Only sufficiently qualified and authorized personnel operate, maintain and repair the Touch PC.
- This personnel is regularly instructed in all applicable questions of occupational safety and environmental protection, and the operating manual and in particular the information contained therein contained in the safety instructions.
- All safety and warning notices attached to the Touch PC are not removed and stay legible.

Depending on the type of machine and system in which the Touch PC is used, there are national regulations for the control of such machines and systems which the operator must comply with. These regulations regulate, among other things, the intervals at which the controller must be checked.

The operator must arrange for this inspection within a certain period of time.

 Attention	<p>Only qualified personnel may open the housing of the Touch Monitor</p> <p>The operator must ensure that only trained electrical specialists open the housing of the Monitor. In this case the warranty will become invalid.</p>
---	---

In the event of faults on the Touch PC, the list in the Troubleshooting section can be used to determine which measures should be taken.

2.4 Requirements for the operating personnel

Every user of the Touch PC must have read this operating manual.

2.5 General Warning

If you notice a burning smell or the device is making noise, disconnect it from the power supply immediately.

 Note	<p>Cleaning</p> <p>To clean the device, switch it off and use a dry, soft cloth with light pressure.</p>
--	---

3. WARRANTY

3.1 Warranty claims & repair

faytech devices are produced following the most modern production and test processes. Carefully selected components and accurate production ensure reliable operation and long life. faytech warrants to the original purchaser that each faytech display delivered shall be free from defects in material or workmanship at time of shipment, and that each such module delivered will meet the published specifications for a period of 24 months as measured from the date of original shipment. faytech's obligation under the Warranty contained herein is limited to the repair or replacement of any faytech touch monitor that does not meet the specifications, provided that said product is returned to faytech, transportation charges pre-paid, and provided that upon faytech's examination, the product, when tested within the specified ratings and in accordance with good engineering practice, does not meet the specifications as defined. THIS WARRANTY IS IN LIEU OF ALL OTHER WARRANTIES, EXPRESSED OR IMPLIED, INCLUDING WITHOUT LIMITATION THE WARRANTY OF MERCHANTABILITY AND THE WARRANTY OF FITNESS FOR A PARTICULAR PURPOSE.

All claims under warranty must be made promptly after occurrence of circumstances giving rise thereto and must be received within the applicable warranty period by faytech or its authorized representative. Such claims should include the Product type and serial numbers and a full description of the circumstances giving rise to the claim. Before any Products are returned for repair and/or adjustment, written authorization from faytech or its authorized representative for the return and instructions as to how and where these Products should be shipped must be obtained. Any product returned to faytech for examination shall be sent prepaid via the means of transportation indicated as acceptable by faytech. faytech reserves the right to reject any warranty claim not promptly reported and any warranty claim on any item that has been altered or has been shipped by non-acceptable means of transportation. When any Product is returned for examination and inspection, or for any other reason, Customer will be responsible for all damage resulting from improper packing or handling and for loss in transit, notwithstanding any defect or nonconformity in the Product. In all cases faytech has sole responsibility for determining the cause and nature of failure, and faytech's determination with regard thereto shall be final. If it is found that faytech's Product has been returned without cause and is still

serviceable, customer will be notified and the Product returned at Customer's expense. In addition, a charge for testing and examination may, in faytech's sole discretion, be made on Products so returned. SELLER'S LIABILITY FOR DAMAGES SHALL NOT EXCEED THE PAYMENT, IF ANY, RECEIVED BY SELLER FOR THE UNIT OF PRODUCT OR SERVICE FURNISHED OR TO BE FURNISHED AS THE CASE MAY BE WHICH IS THE SUBJECT OF CLAIM OR DISPUTE. IN NO EVENT SHALL SELLER BE LIABLE FOR INCIDENTAL, CONSEQUENTIAL OR SPECIAL DAMAGES. LIABILITY TO THIRD PARTIES, FOR BODILY INJURY INCLUDING DEATH, RESULTING FROM SELLER'S PERFORMANCE SHALL BE DETERMINED IN ACCORDANCE WITH APPLICABLE LAW AND THE TOTAL LIABILITY LIMITATION STATED ABOVE SHALL NOT BE CONSTRUED AS A LIMITATION ON SELLER FOR DAMAGES FOR ANY SUCH BODILY INJURY, INCLUDING DEATH.

WARRANTY FOR ITEMS REPLACED UNDER WARRANTY Whenever a failed module is replaced under Warranty, the greater of the balance of the original Warranty Period or 90 days will constitute the remaining warranty period. The replaced unit does not carry a new Warranty.

3.2 Life support policy warning

LIFE SUPPORT POLICY "WARNING: DO NOT USE IN LIFE SUPPORT" SELLER'S PRODUCTS ARE NOT AUTHORIZED FOR USE AS CRITICAL COMPONENTS IN LIFE SUPPORT DEVICES OR SYSTEMS WITHOUT THE EXPRESS PRIOR WRITTEN APPROVAL OF THE CEO OF FAYTECH. As used herein, "Life Support Devices or Systems" are devices which support or sustain life and whose failure to perform when properly used in accordance with instructions for use provided in the labeling can be reasonably expected to result in a significant injury to the user. A "Critical Component" is any component in a life support device or system whose failure to perform can be reasonably expected to cause the failure of the life support device or system or to affect its safety or effectiveness.

3.3 In case of defect

If your device does have a defect within the warranty period, please contact faytech directly. The warranty period is 24 months from the date of purchase under the following conditions:

- All warranties are void if the unit has been opened or disassembled without faytech's prior approval.
- Damage caused by improper handling or operation, by incorrect installation or storage, through improper connections, as well as due to force majeure or other external influences are not covered by the warranty.
- For warranty claim, we reserve the right to replace the defective components or to exchange the device.
- Exchanged components or devices become the property of faytech.
- Claims for damages are excluded in so far as they are not based on intent or gross negligence of the manufacturer.
- After expiration of the warranty period, warranty claims can no longer be pursued.
- Any warranty claim must be accompanied by proof of purchase (receipt or invoice).

4. PRODUCT DESCRIPTION

4.1 Appropriate use

The faytech Capacitive Touch PCs are used in many different application areas, such as but not limited to: industrial, medical and retail applications.



Front of the Capacitive Touch PC (15.6" as example)



Right side of the Capacitive Touch PC (15.6" as example)

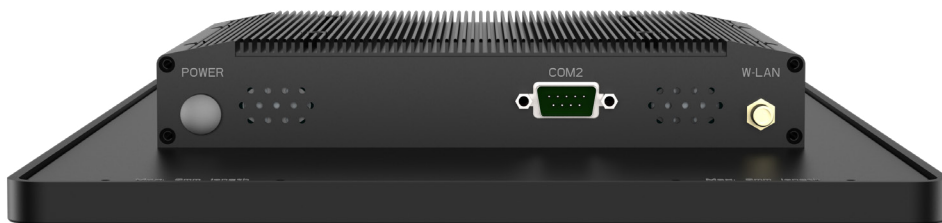

Left side of the Capacitive Touch PC (15.6" as example)

4.2 Interfaces

Interfaces of the Capacitive Touch PCs

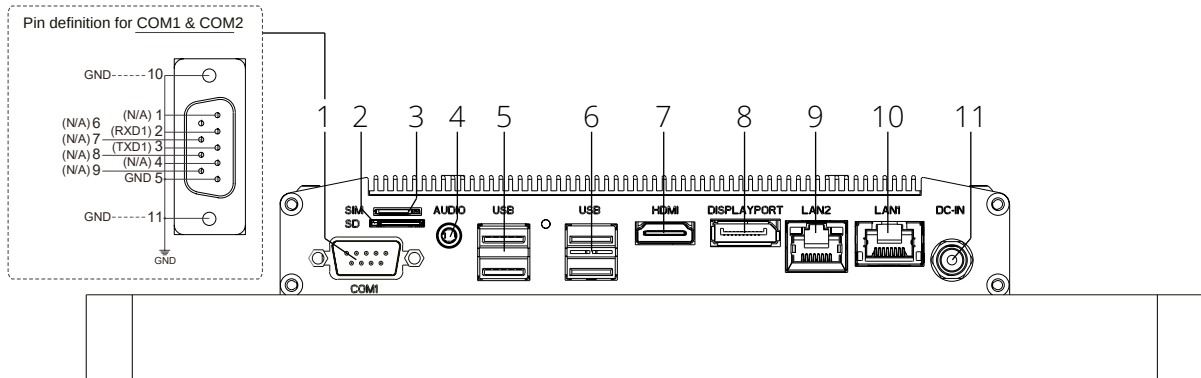

Right side of the
Capacitive Touch PC

COM1 serial port RS232 (RX / TX only)

The serial interface DSUB9 port for COM1 (1) is standard set at RS232 with RX / TX only. If your device was configured for RS485 Pin2 Rx will become A and Pin3 Tx will become B. See the pin definition and options in the illustration above.

SD slot / SIM-card slot

The SD slot (2) allows for insertion of a small removable memory card to save, store and transfer data. The SIM-card slot (3) is standard deactivated, and requires additional LTE module and antenna before being able to be used. Once active it allows for cellular connectivity.

Audio in / out

The audio in / out connection (4) has a diameter of 3.5 mm and is used for transmitting audio signals.

USB interfaces

The four USB interfaces (5, 6) are used to connect peripheral devices with USB connection. The USB 3.2 standard (5) and USB 2.0 standard (6) are supported.

HDMI (High-Definition Multimedia Interface)

The HDMI terminal (7) is for transmitting the video signal.

DP (DisplayPort)

The DP connector (8) is for transmitting the video signal.

LAN connectors

The RJ-45 sockets LAN1 and LAN2 (9, 10) enables the Touch PC to be connected to a 10/100/1000 BASE-T network. RJ-45 socket LAN1 (10) has a PoE option, but this requires the PoE module accessory. If this module accessory is assembled, the 12V DC-In below is without function.

Power supply

The power supply of the Touch PC is established via the socket (11). The DC-In input (screwable) is either 9-36V or 12V, depending on the individual product.

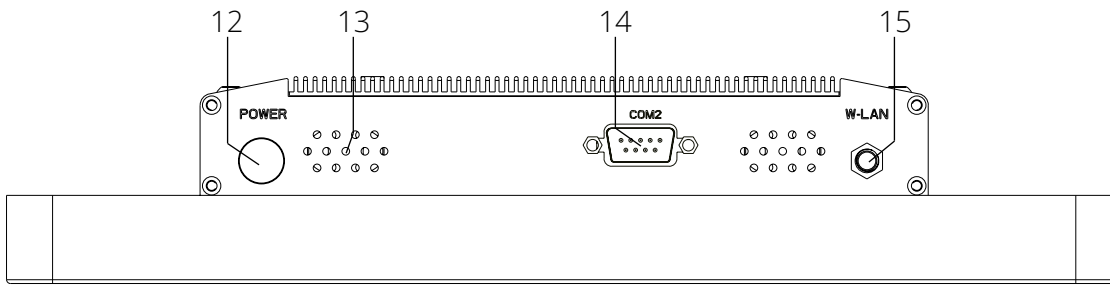

Left side of the Capacitive Touch PC

On / Off switch

With the button (12) the touch PC can be switched on and off.

Audio speakers

This Integrated audio speaker (13) is a 2W audio speaker, and the touch PC has two on the left side.

COM2 serial port RS232 (RX / TX only)

The serial interface DSUB9 port for COM2 (14) is standard set at RS232 with RX / TX only, If your device was configured for RS485 Pin2 Rx will become A and Pin3 Tx will become B. The pin definition and options are the same as COM1, as shown in the illustration on the previous page. Keep in mind, this connector is only included in the large back-kit version, thus not available for sizes 7" and 8".

W-LAN antenna connector

The antenna connector (15) of the Touch PC enables the connection via W-LAN with the supplied antenna. Frequency band: 2.4GHz, Gain: 2dBi (±0.5). Max. Transmission power: 2mW (with supplied antenna) / 6.3mW (maximum with any antenna),

4.3 Status LED



No LED

The Touch PC is switched off.



Green LED

The Touch PC is switched on.



Attention

Moving or cleaning the device

Make sure that you only clean or move the device when the LED light is off.

4.4 Scope of delivery

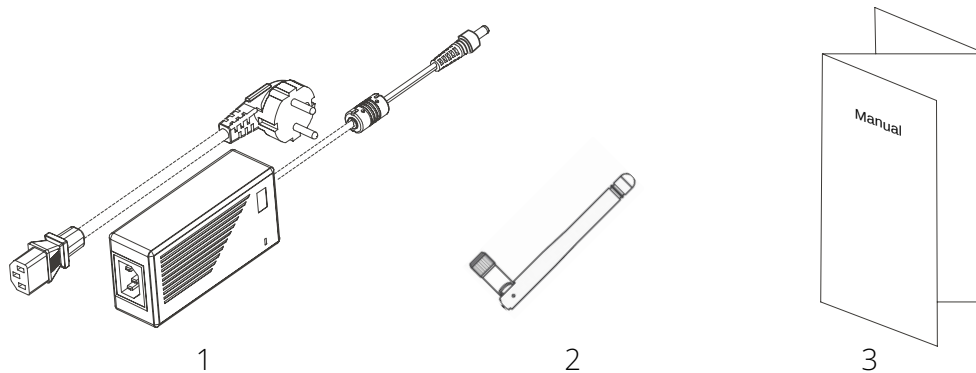

Power supply unit

The supplied power supply unit (**1**) has a screwable connection. The power supply is 100-240V AC 50-60 Hz with 2A, 3A or 5A, depending on the product.

W-LAN antenna

The supplied W-LAN antenna (**2**) can be screwed onto the W-LAN connector to connect the Touch PC to a wireless network (Internet). The antenna included in the package has an RP-SMA female connector. Frequency band: 2.4GHz / Max. Transmission power: 2mW

Brief instructions

This quick guide (**3**) contains the most important information about the Touch PC.
Unplugging Instructions

5. INSTALLATION INSTRUCTIONS

5.1 Transportation

Despite the robust design, the built-in components are sensitive to strong vibrations and shocks. Therefore, protect your touch PC from high mechanical stress during transport. Use the original packaging for shipping.

 Attention	Risk of damage to the device When transporting the device in cold weather or if the device is exposed to extreme temperature fluctuations, make sure that no moisture (condensation) condenses on or in the device. Allow the device to slowly adjust to room temperature before putting it into operation. If there is condensation, the unit may only be switched on after a waiting period of about 12 hours.
---	---

5.2 Unpacking

Proceed as follows when unpacking the device:

1. Remove the packaging.
2. Do not throw away the original packaging. Keep it for re-transport.
3. Check the delivery for completeness based on your order.
4. Please keep the documents supplied with the device; they contain important information about the device and on how to use it.
5. Check the package contents for visible transport damage.
6. If you notice transport damage or discrepancies between the contents of the package and your order, please inform the faytech service team.

5.3 Mounting options

There are several ways to mount the device:

1. Use the VESA 100 holes on the back to mount the unit on a wall or stand.



2. Use the U-profile brackets in combination with the VESA holes to integrate the unit into a cabinet or cut-out.

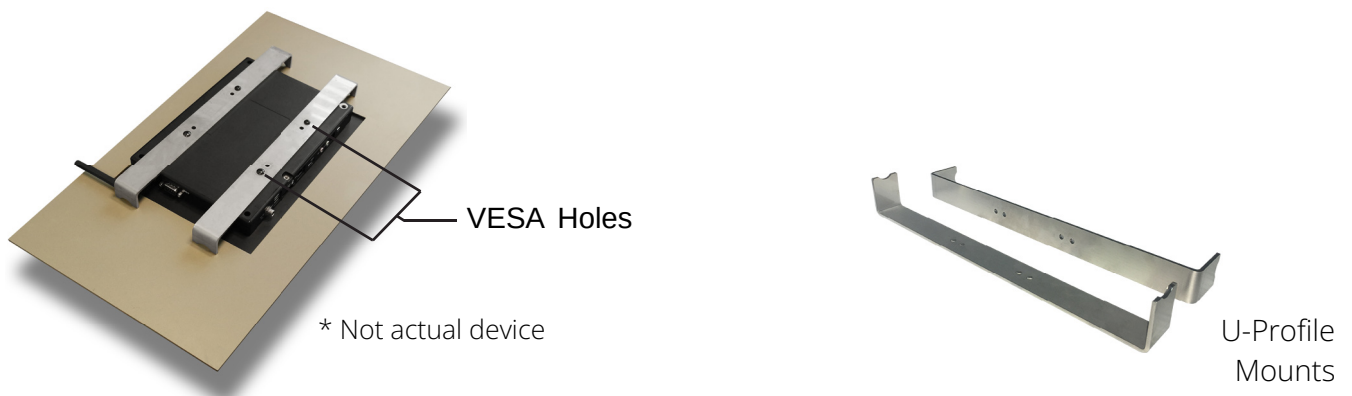

3. Use the mounting brackets to integrate the device into a cabinet. This mounting solution uses the screw holes that can be used for all peripherals.

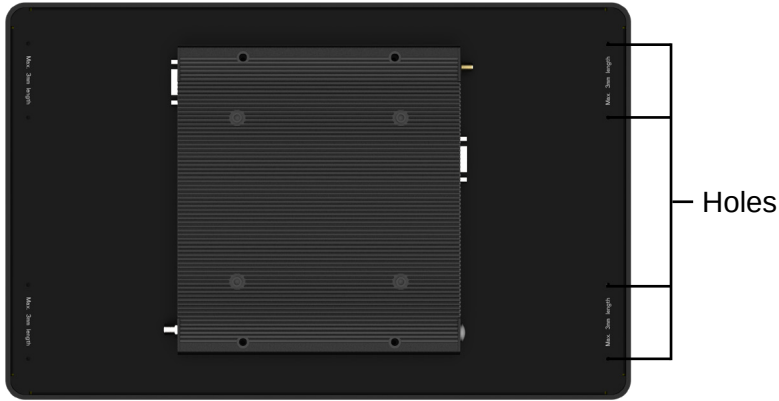

* Not available for 7" and 8" sizes



Clamp Supports

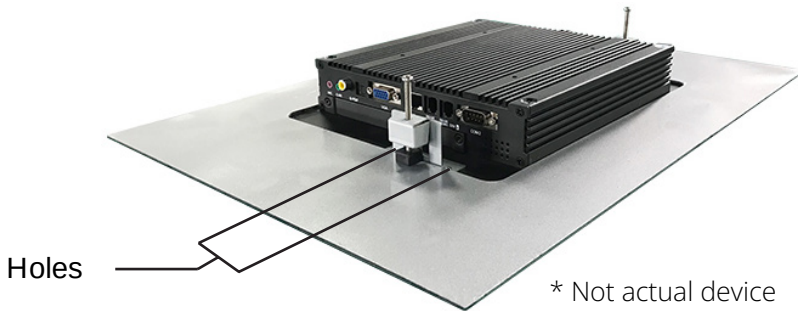

* Not actual device

 <p>Note</p>	<p>Cut-out requirements</p> <p>Keep in mind that the cut-out size differs per device. So, ensure to follow the proper instructions for each of these mounting solutions:</p> <p><u>U-Profile Mounts documentation</u> - https://bit.ly/3fskMGw</p> <p><u>Clamp Support documentation</u> - available on each separate product specification sheet (www.faytech.com)</p>
--	--



 <p>Note</p>	<p>Own mounting solution</p> <p>Of course it is also possible to use your own mounting solutions. faytech is not responsible for the proper use of the mountings.</p>
--	--

5.4 Connecting the device

The connectors are located at the rear of the Touch PC and are documented in the chapter Product Description. To start the device, connect it to a power source with the supplied AC adapter or use a corresponding 12V DC power source (or 9-36V for certain solutions, if specified). For all power information see the respective product label.

After connecting the power adapter to the power source, a green LED light on the power box should illuminate. The LED light on the Touch PC should turn red.



 <p>Attention</p>	<p>Own power supply</p> <p>Only use your own power supply unit if you are aware of the use of the power supply unit. If the wrong voltage is used, it may destroy the unit.</p>
 <p>CAUTION</p>	<p>Fire or smoke</p> <p>If the appliance catches fire or starts smoking, immediately unplug the appliance and then extinguish with powder or nitrogen.</p>

5.5 Driver installations

In order to fully utilize all functions of the faytech Touch PCs, it is recommended to download the required drivers from the faytech website in the download section (www.faytech.com/downloads/).

Drivers available on our website for these product series:

Elkhart Lake Mainboard Drivers (x6413E / x6211E / J6412) – WIN10 & 11

All drivers packed together, related to this product series with Windows 10 & 11 OS.

Tiger Lake U Mainboard Drivers (i3 / i5 / i7) – WIN10 & 11

All drivers packed together, related to this product series with Windows 10 & 11 OS.

W-LAN Driver

This driver is focused on the W-LAN function of the Touch PCs. with it. The product is turned on

While the below Linux and Windows drivers are available for download, they are not suggested. Instead, the native OS drivers should be used (Plug and Play).

Capacitive Touch Driver - Linux/Debian

This is the capacitive touch driver to work with the Debian and Linux operating systems.

Capacitive Touch Driver - All OS (except Linux)

This is the capacitive touch driver to work with all operating systems, except Linux.
OS's included: Android, MS-DOS, macOS, QNX and Windows.

6. OPERATING INSTRUCTIONS

6.1 Initial power-up and driver installation

To turn the unit on, press the power button on the back or side of the unit. When you turn on the Touch PC for the first time, the pre-installed operating system (Debian, Linux or Windows) will start.

 Attention	<p>First shut down, then switch off</p> <p>If the Touch PC is switched off while the software is writing a file to the hard disk, this file will be destroyed. Control software usually writes something to the hard disk on its own at intervals of a few seconds, so the probability of causing damage by switching off while the software is running is very high.</p>
---	--

To get the most out of your device, you must download the correct drivers for your device. You can find these drivers on the website under Downloads: www.faytech.com/downloads. This series uses the Elkhart Lake and Tiger Lake U mainboards and therefore requires the appropriate drivers for this specific series.

6.2 BIOS settings

Details on how to get into the BIOS is explained below. Please note that this is a special BIOS for integrated monitor PC solutions. Accordingly, after adjustments in the BIOS, you may not be able to see an image on your Touch PC screen. For this reason only experienced users should make changes to the BIOS. If the system is adjusted, proceed as follows: Press "Del" on a connected keyboard (even if you do not see an image) until you are sure that you are in the BIOS. Then press F5, Enter, F10, Enter. The system will reboot and you should have a picture on your display again.

 Note	<p>Debian/Linux Preinstalled</p> <p>If a current Ubuntu is preinstalled on your Touch-PC with integrated SSD, the username is "User" and the password "user123".</p> <p>If you want to change the password, open a terminal. Type "sudo su", "enter". The password is still "user123". Then "passwd user" and enter the new password.</p>
--	--

6.3 Troubleshooting

No image

1. First check whether the power supply is correctly connected and working (green LED on power supply unit).
2. When installing new graphics card drivers, the BIOS might be changed and no boot screen is visible. Wait one to two minutes until Windows is loaded.
3. Connect an external keyboard via USB and check whether the Num-Lock LED of the Keyboard lights up (press Num-Lock). If this lights up, there is usually only an incorrect BIOS. Turn off the computer again, restart it and press "Del" until you are sure that you are in the BIOS. Set the graphics options in the BIOS according to the Chapter BIOS Settings.
4. If none of the above points leads to success, please contact our direct Manufacturer service, under the contact details given on the Service and Support page.

Touch function is not accurate

1. Please download the latest touch drivers from our website www.faytech.com and perform a recalibration to recalibrate the touch screen.

6.4 FAQs

How do I connect the touch display to the appropriate power supply?

All displays have an external power supply. Therefore you have two possibilities: You can use the 12V DC power supply unit included in the scope of delivery, or your own suitable power supply capable of supplying 12V DC power.

The touch function does not work properly, what can I do?

If you have problems with the touch, please check if the driver and all cables are installed correctly. Otherwise the most common error is caused by the protective foil on the touch display. Please remove the protective foil to get the best possible use out of the display.

Does the touch functionality affect the image quality?

No, the touch panel is transparent and non-reflective. So you will not notice the additional panel.

7. SERVICE AND SUPPORT

7.1 Service

If you think your faytech product has a defect please always contact us directly. Our trained after sales service specialists can help you to resolve your problems regarding the device. Please check the manual and our frequently asked questions before contacting us – you will usually find an answer to your question.

Please attach your invoice and a detailed description of the issues you are facing with your device to your contact E-mail/fax. In reply, you will receive an e-mail/fax with your RMA number and additional information. For defective accessories that were content of the original delivery, we usually send you a replacement before receiving the damaged goods. In case of a defective product, we try to check and solve the problem within 3 working days after receipt. Make sure that shipping has been paid before sending the goods back to us. We do not accept postage due packages at our service centers. Anything shipped with postage due will be rejected. Within the first 30 days after the purchase of a new faytech product, we will refund the shipping costs for returned defective products. For the rest of the warranty period, we will only cover shipping costs for repaired or replaced items that we ship back to you (one way).

For support outside of China, we work with local representatives / local service partners together who may work on our behalf in our name. For more information, feel free to contact us under the following contact details.

7.2 Contact

Global Support: +86 755 89580612

Support Europe: +49 761 4514 0

Support North America: +1 646 843 0877

Support India: +91 9843429654

Support Japan: +81 366 722 920

Support South Korea: +82 10 8589 7231

Support E-Mail: support@faytech.com

Homepage (Global): <https://www.faytech.com/>

Homepage (Europe): <https://www.pyramid-computer.com/faytech>

Support Page: <https://www.faytech.com/rma/>

EMEA Headquarters

Pyramid Computer GmbH

Bötzingen Strasse 60

79111 Freiburg

Germany

APAC Headquarters

faytech Tech. Co., Ltd.

Fl. 2, Bldg. 8, Winlead Intelligent Park,

Bantian, Shenzhen

China

8. APPENDIX

8.1 CE and UKCA - Declaration of Conformity

Hereby faytech declares that the equipment is in compliance with the essential requirements and other relevant regulations of the directives 2014/30/EU, 2014/35/EU, 2011/65/EU, 2015/863 RoHS, UK SI 2016/1091 and UK SI 2016/1101.

The long version of the CE Declaration of Conformity can be found in English at: www.faytech.com/ce

Version 1.0

Elkhart Lake & Tiger Lake U

Product Series